

NIP.MICRO 2,7 Ø3X5 OSK MESSING PAN

Product Images



Algemene specificaties

- Schuifbediening
- Compact
- De schuifhuls beschermt de body van de koppeling tegen vuil
- Alternatief voor Parker/Rectus 20
- Geschikt voor pneumatiek, meet- en regeltechniek en vacuüm tot 0,8 bar

Schuifbediening



Koppelen: steek de nippel in de koppeling.



Ontkoppelen: Schuif de huls van de koppeling naar achteren.

Materialen

Body	Messing MS 58
Huls	Messing MS 58
Body klep	Messing MS 58
Klep	Messing MS 58
Plug	Messing MS 58
Vering	RVS 1.4310
Borgring	RVS 1.4310
Lagers	RVS 1.3541
Afdichtingen	NBR

Specificaties

Maximale werkdruk	35 bar
Werktemperatuur	-20 °C - +100 °C
DN	2.7
Draad	ISO 228/DIN 13
Flow	165 l/min (6 bar bij ΔP 0,1 bar)
Bediening	Schuifbediening
Media	Lucht/overig

Enkelzijdige afsluiting



Koppeling - nippel

Dimensies

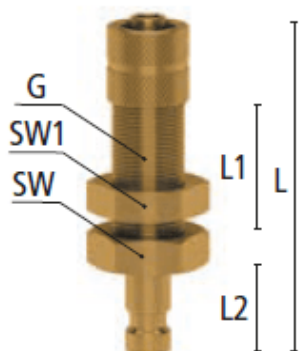

Artikelnummer	Ø Slang	L	SW	L1	L2	SW1	G	Gewicht
ESMC34SQSV	3 x 4 mm	38	12	17	10	11	M 7 x 0,5 mm	23
ESMC35SQSV	3 x 5 mm	38	12	17	10	11	M 7 x 0,5 mm	23
ESMC4SQSV	4 x 6 mm	38	12	17	10	12	M 8 x 0,5 mm	23

Additional Information

EAN Code	8719426394441
Artikelnummer	ESMC35SQSV
Omschrijving	Insteeknippel opschroefwartel paneelmontage
Merk	Ludecke
Doorlaat	DN 2,7
Fabrikant	Ludecke
Insteeknippel of snelkoppeling?	Insteeknippel
Profiel	Overig
Veiligheidsnorm	Niet conform ARBO
Aansluiting	Ø3x5mm
Klep	Nee
Materiaal	Messing
Type aansluiting	Opschroefwartel