

# MESS. NO 2/2 VENT G1/4 Ø2.0 FKM

## Product Images

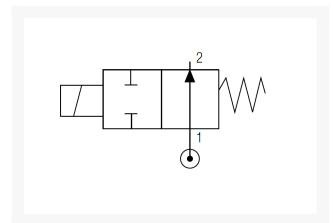

## Omschrijving

De 01F 2/2 ventielen van [Aignep](#) met een FKM afdichting zijn geschikt voor Minerale oliën, benzine, gasolie en stookolie.

- Maximale werkdruk: 40 bar
- Minimale werktemperatuur: -10°C
- Maximale werktemperatuur: +140°C
- **LET OP! Spoel niet inbegrepen. Zie gerelateerde producten (rechts)**

## Opbouw artikelnummer

SERIE	GROOTTE	FUNCTIE	DOORLAAT	MATERIAAL AFDICHTING	
01F	03	1	04	N	0
	03 = 1/4 04 = 3/8 05 = 1/2	1 = 2/2 NC 2 = 2/2 NO 3 = 3/2 NC 4 = 3/2 NO	15 = 1,5 mm 02 = 2 mm 25 = 2,5 mm 03 = 3 mm 04 = 4 mm 05 = 5 mm	N = NBR E = EPDM V = FKM	

## Afmetingen

NO



1/8

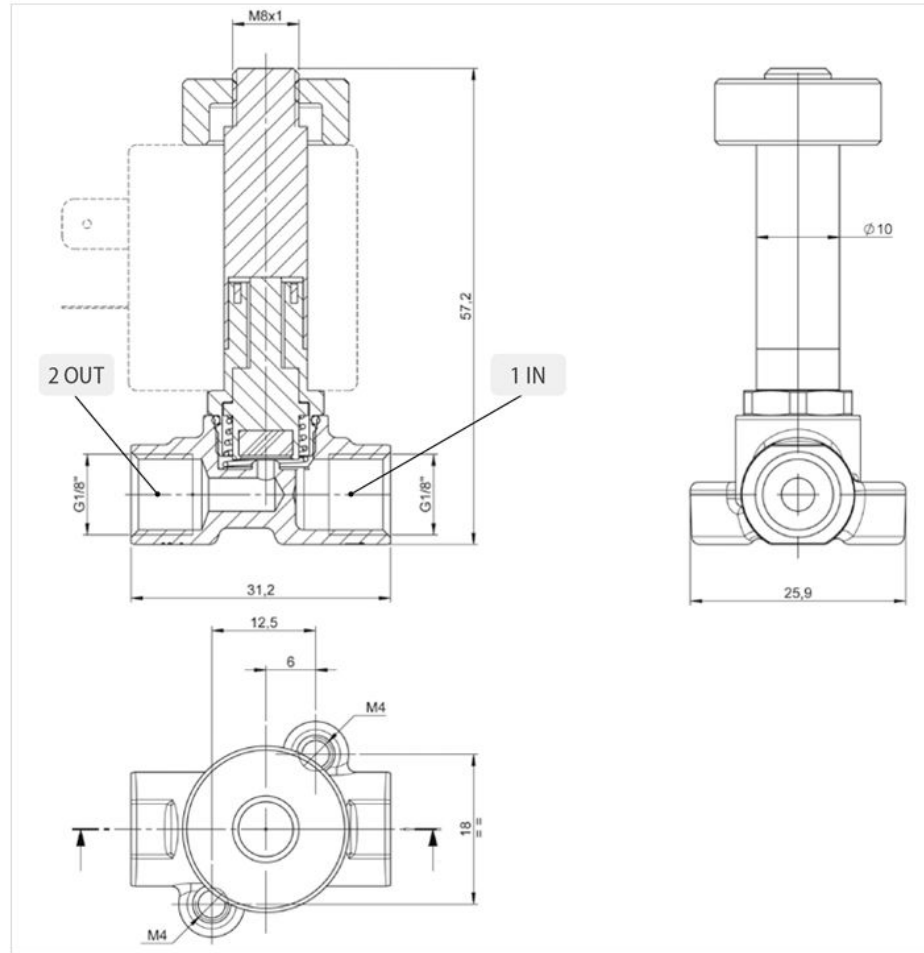

1/4

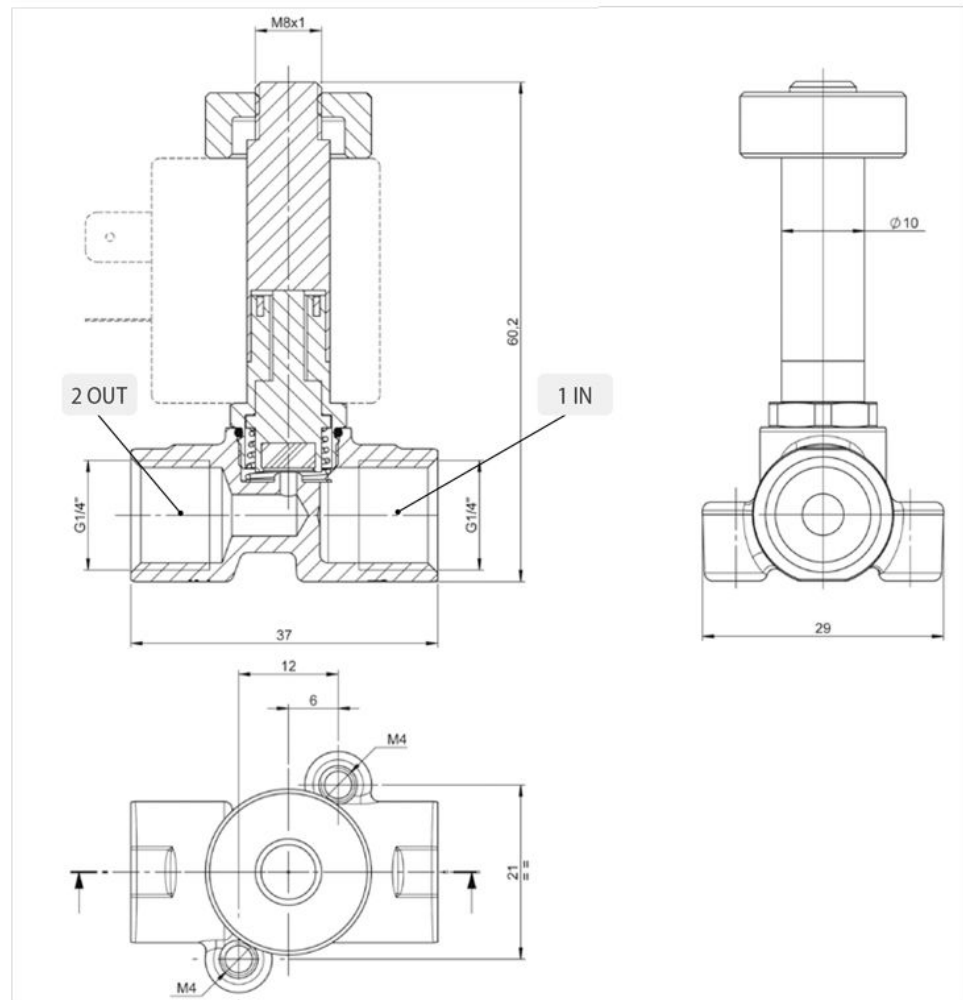

Artikelnummer	Afdichting	Draadmaat	Ø mm	Viscositeit	Kv m3/h	Vermogen		ΔP bar	
						DC	AC	min	max
		ISO228		Max cSt		W	VA		
<b>01F 02 2 15 N 0</b>	NBR	1/8"	1,5	25	0.06	8	-	0	17
<b>01F 02 2 15 V 0</b>	FKM					-	7.5	0	17
<b>01F 02 2 15 E 0</b>	EPDM					-	11	0	17
<b>01F 02 2 02 N 0</b>	NBR	1/8"	2	37	0.09	8	-	0	9.5
<b>01F 02 2 02 V 0</b>	FKM					-	7.5	0	9.5
<b>01F 02 2 02 E 0</b>	EPDM					-	11	0	9.5
<b>01F 02 2 25 N 0</b>	NBR	1/8"	2.5	53	0.15	8	-	0	6.1
<b>01F 02 2 25 V 0</b>	FKM					-	7.5	0	6.1
<b>01F 02 2 25 E 0</b>	EPDM					-	11	0	6.1
<b>01F 02 2 03 N 0</b>	NBR	1/8"	3	53	0.20	8	-	0	4.2
<b>01F 02 2 03 V 0</b>	FKM					-	7.5	0.7	4.2
<b>01F 02 2 03 E 0</b>	EPDM					-	11	0	4.2
<b>01F 02 2 04 N 0</b>	NBR	1/8"	4	53	0.30	8	-	0	2.4
<b>01F 02 2 04 V 0</b>	FKM					-	7.5	0	2.4
<b>01F 02 2 04 E 0</b>	EPDM					-	11	0	2.4
<b>01F 03 2 15 N 0</b>	NBR	1/4"	1,5	25	0.06	8	-	0	17
<b>01F 03 2 15 V 0</b>	FKM					-	7.5	0	17
<b>01F 03 2 15 E 0</b>	EPDM					-	11	0	17
<b>01F 03 2 02 N 0</b>	NBR	1/4"	2	37	0.09	8	-	0	9.5
<b>01F 03 2 02 V 0</b>	FKM					-	7.5	0	9.5
<b>01F 03 2 02 E 0</b>	EPDM					-	11	0	9.5
<b>01F 03 2 25 N 0</b>	NBR	1/4"	2.5	53	0.15	8	-	0	6.1
<b>01F 03 2 25 V 0</b>	FKM					-	7.5	0	6.1
<b>01F 03 2 25 E 0</b>	EPDM					-	11	0	6.1

<b>01F 03 2 03 N 0</b>	NBR	1/4"	3	53	0.20	8	-	0	4.2
<b>01F 03 2 03 V 0</b>	FKM					-	7.5	0.7	4.2
<b>01F 03 2 03 E 0</b>	EPDM					-	11	0	4.2
<b>01F 03 2 04 N 0</b>	NBR	1/4"	4	53	0.30	8	-	0	2.4
<b>01F 03 2 04 V 0</b>	FKM					-	7.5	0	2.4
<b>01F 03 2 04 E 0</b>	EPDM					-	11	0	2.4

## Additional Information

---

EAN Code	8719426406205
Artikelnummer	01F03202V0
Omschrijving	NO 2/2 FKM, doorlaat Ø2,0 mm