

MESS. NC 2/2 VENT G1/8 Ø2.5 NBR

Product Images

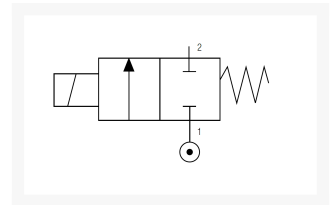

Omschrijving

De 01F 2/2 ventielen van [Aignep](#) met een NBR afdichting zijn geschikt voor lucht, inert gas, water max 75 ° C, minerale oliën, gasolie en stookolie.

- Maximale werkdruk: 40 bar
- Minimale werktemperatuur: -10°C
- Maximale werktemperatuur: +90°C
- **LET OP! Spoel niet inbegrepen. Zie gerelateerde producten (rechts)**

Opbouw artikelnummer

SERIE	GROOTTE	FUNCTIE	DOORLAAT	MATERIAAL AFDICHTING	
01F	03	1	04	N	0
	03 = 1/4 04 = 3/8 05 = 1/2	1 = 2/2 NC 2 = 2/2 NO 3 = 3/2 NC 4 = 3/2 NO	15 = 1,5 mm 02 = 2 mm 25 = 2,5 mm 03 = 3 mm 04 = 4 mm 05 = 5 mm	N = NBR E = EPDM V = FKM	

Afmetingen

NO



1/8

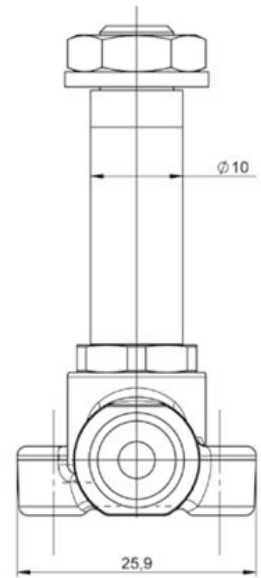
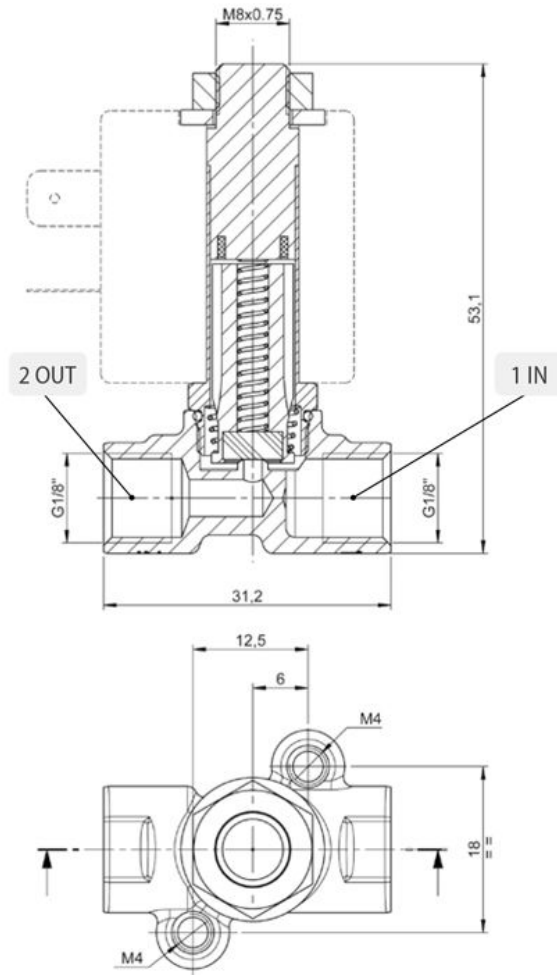

1/4

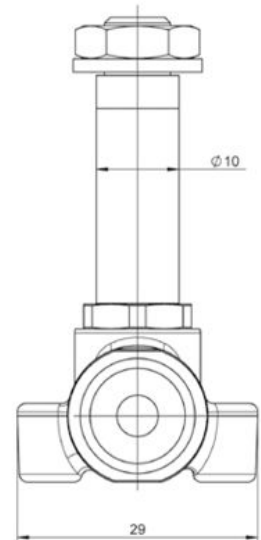
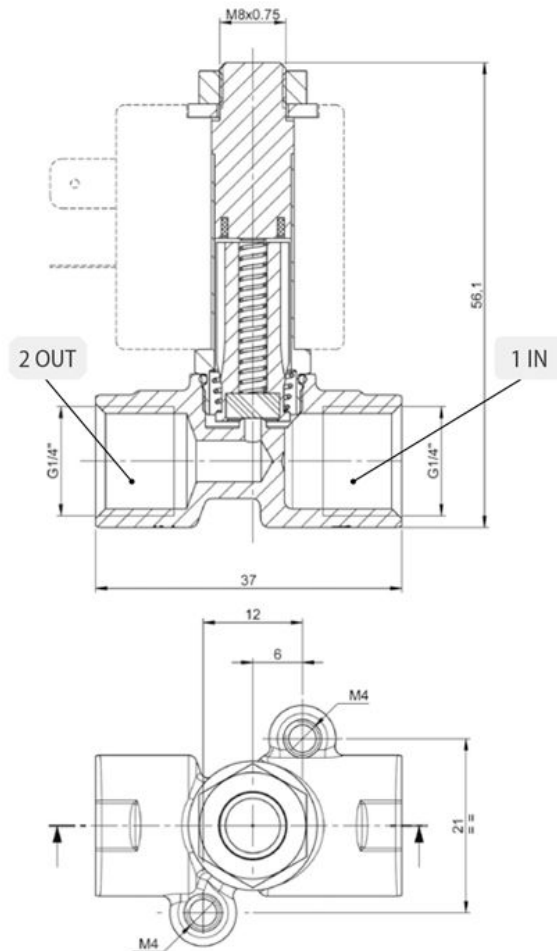

2/2 NC

Artikelnummer	Afdichting	Draadmaat	Ø mm	Viscositeit	Kv m3/h	Vermogen		ΔP bar	
						DC	AC	min	max
		ISO228		Max cSt		W	VA		
01F 02 1 15 N 0	NBR	1/8"	1,5	25	0.06	6.5	-	0	21.1
01F 02 1 15 V 0	FKM					8	-	0	40
						-	7.5	0	26
01F 02 1 15 E 0	EPDM					-	11	0	40
01F 02 1 02 N 0	NBR	1/8"	2	37	0.09	6.5	-	0	11
01F 02 1 02 V 0	FKM					8	-	0	28.7
						-	7.5	0	13.6
01F 02 1 02 E 0	EPDM					-	11	0	32.3
01F 02 1 25 N 0	NBR	1/8"	2.5	53	0.15	6.5	-	0	3.7
01F 02 1 25 V 0	FKM					8	-	0	11
						-	7.5	0	6.1
01F 02 1 25 E 0	EPDM					-	11	0	16.4
01F 02 1 03 N 0	NBR	1/8"	3	53	0.20	6.5	-	0	1.7
01F 02 1 03 V 0	FKM					8	-	0	6.2
						-	7.5	0	3.6
01F 02 1 03 E 0	EPDM					-	11	0	9.8
01F 02 1 04 N 0	NBR	1/8"	4	53	0.30	6.5	-	0	1.0
01F 02 1 04 V 0	FKM					8	-	0	2.2
						-	7.5	0	1.4
01F 02 1 04 E 0	EPDM					-	11	0	4.6
01F 03 1 15 N 0	NBR	1/4"	1,5	25	0.06	6.5	-	0	21.1
01F 03 1 15 V 0	FKM					8	-	0	40
						-	7.5	0	26
01F 03 1 15 E 0	EPDM					-	11	0	40

01F 03 1 02 N 0	NBR					6.5	-	0	11
01F 03 1 02 V 0	FKM	1/4"	2	37	0.09	8	-	0	28.7
	-					7.5	0	13.6	
01F 03 1 02 E 0	EPDM					-	11	0	32.3
01F 03 1 25 N 0	NBR					6.5	-	0	3.7
01F 03 1 25 V 0	FKM	1/4"	2.5	53	0.15	8	-	0	11
	-					7.5	0	6.1	
01F 03 1 25 E 0	EPDM					-	11	0	16.4
01F 03 1 03 N 0	NBR					6.5	-	0	1.7
01F 03 1 03 V 0	FKM	1/4"	3	53	0.20	8	-	0	6.2
	-					7.5	0	3.6	
01F 03 1 03 E 0	EPDM					-	11	0	9.8
01F 03 1 04 N 0	NBR					6.5	-	0	1.0
01F 03 1 04 V 0	FKM	1/4"	4	53	0.30	8	-	0	2.2
	-					7.5	0	1.4	
01F 03 1 04 E 0	EPDM					-	11	0	4.6

Additional Information

EAN Code	8719426405628
Artikelnummer	01F02125N0
Omschrijving	NC 2/2 NBR, doorlaat Ø2,5 mm