

# GELEIDE COMP CIL BB Ø32-150 GEDEMPT

## Product Images

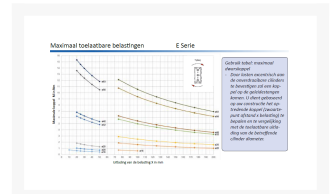
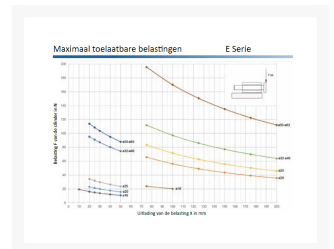
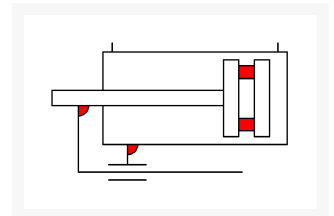
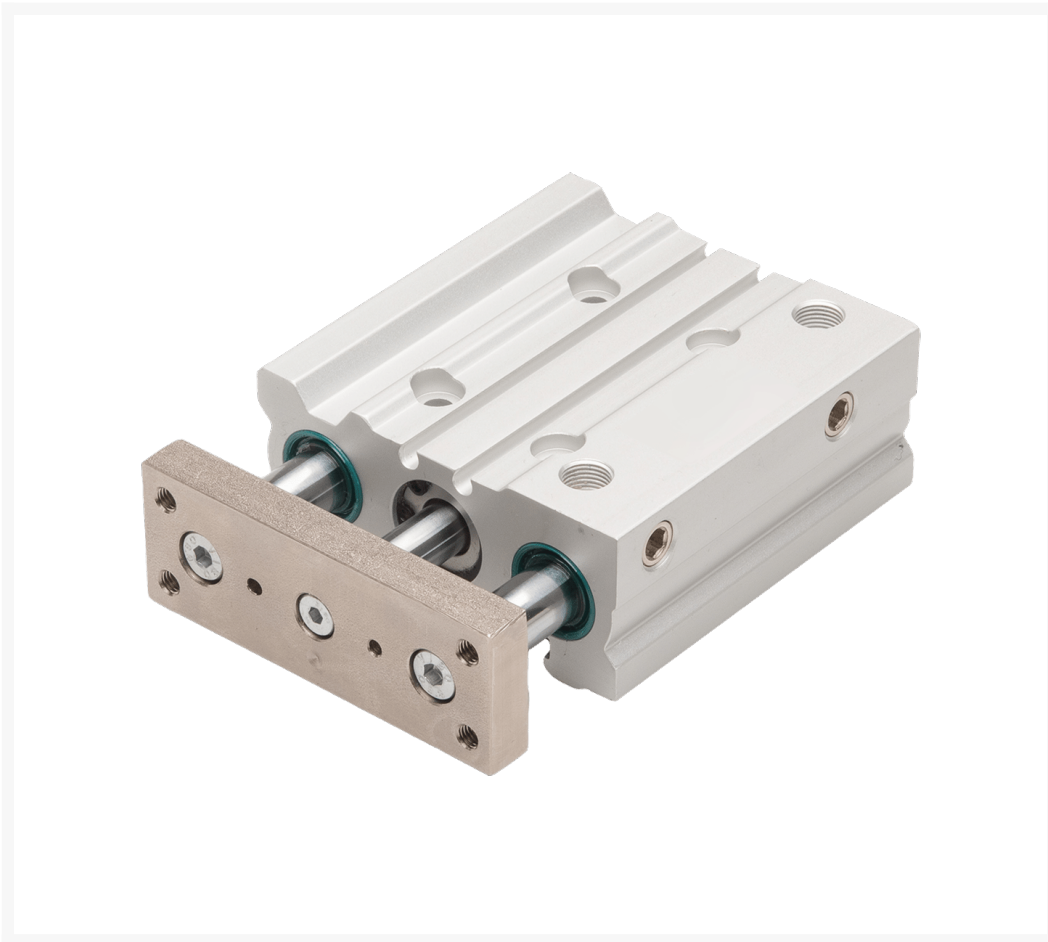

## Omschrijving

De E-Serie is het assortiment geleidecilinders van Artec welke uitwisselbaar zijn met geleidecilinders van o.a. Festo. De EDM cilinders hebben een boring van 16 tot 63 mm en standaard slagen tot wel 200 mm. Deze cilinders zijn verkrijgbaar in de dubbelwerkende versie, zowel magnetisch als niet-magnetisch, met bronzen bus. Een versie met pneumatische demping is op aanvraag beschikbaar. De afdichtingen zijn van polyurethaan en gebaseerd op FKM (bestand tegen hoge temperaturen).

De behuizing van E-Serie cilinders bestaat uit een profielbuis met C-vormige sleuven, waarmee magnetische sensoren kunnen worden geplaatst.

## Koppel

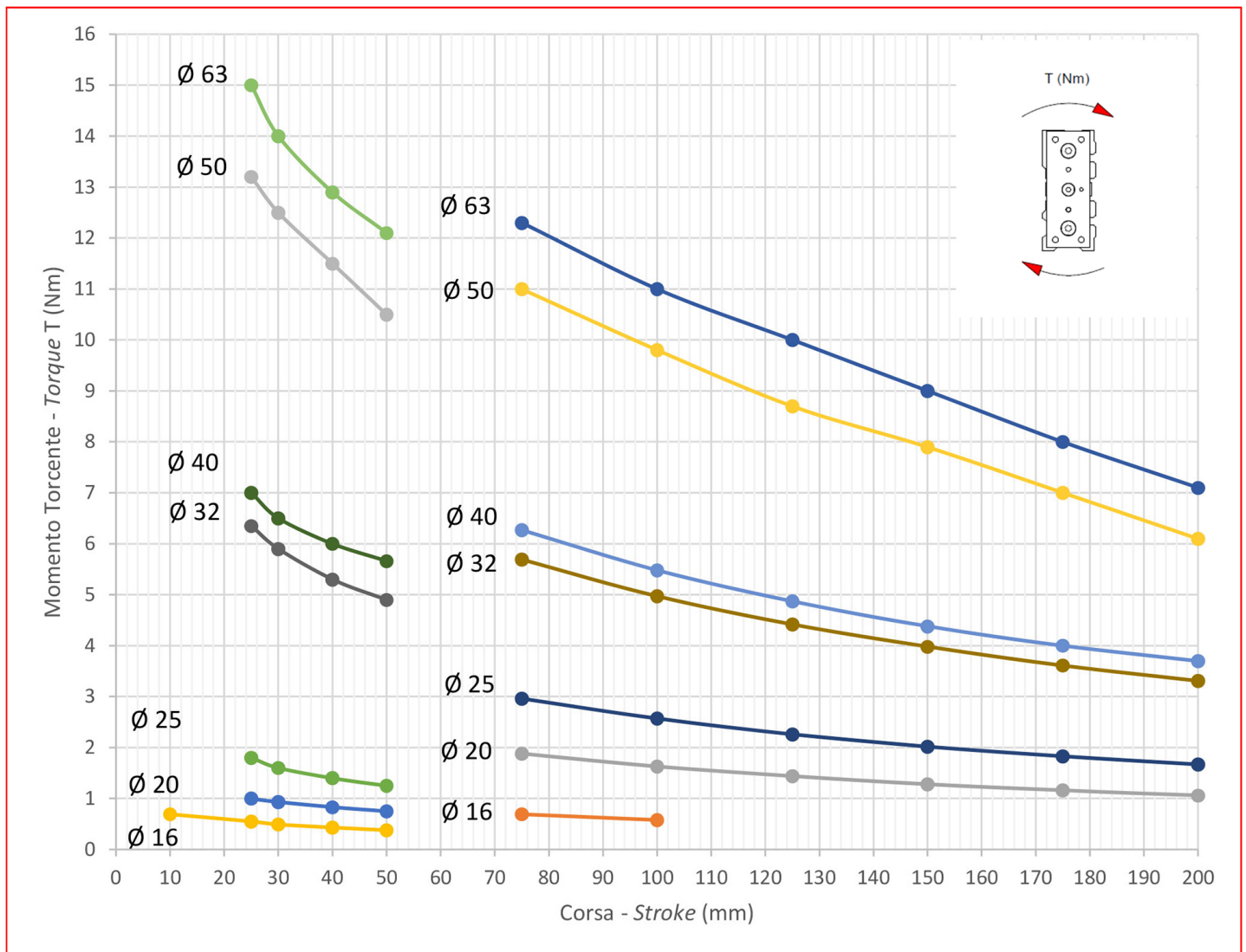

## Zijdelingse belasting

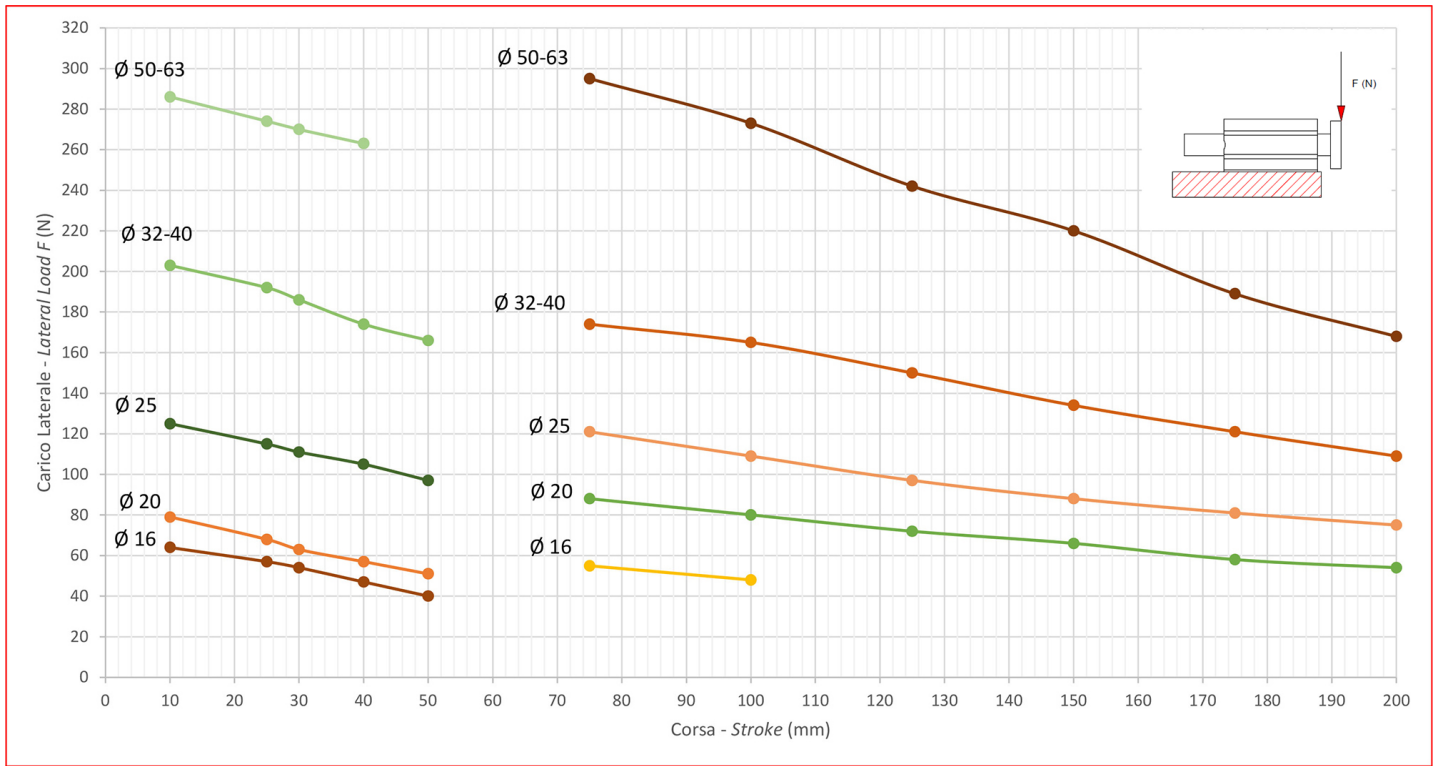

# Maatvoering

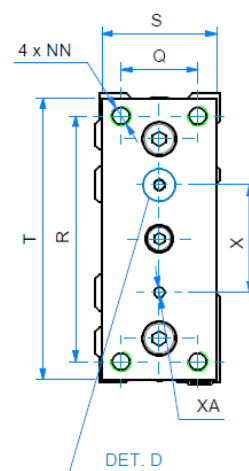
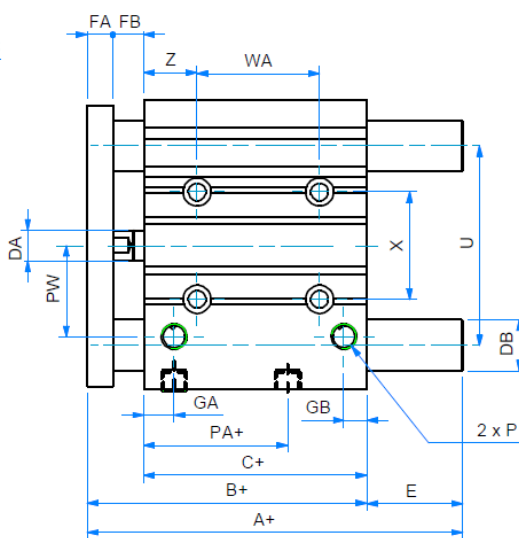
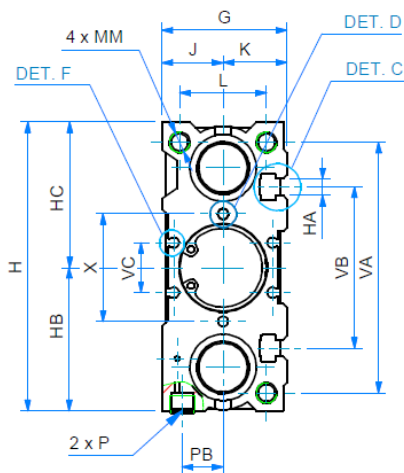
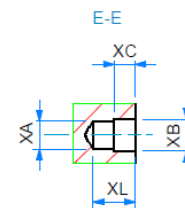
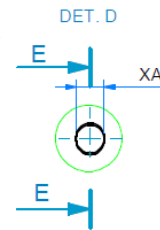
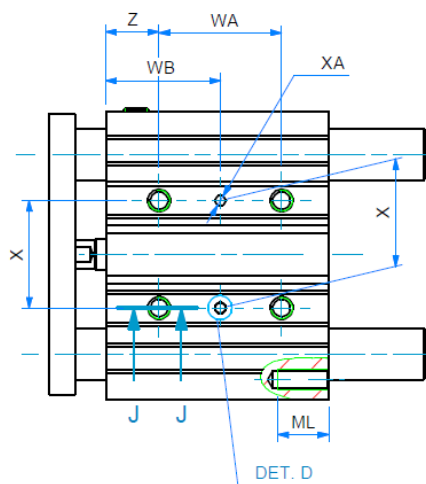
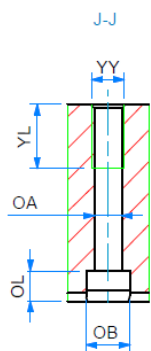
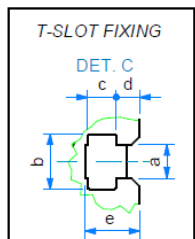
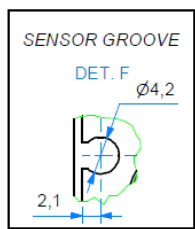

Ø	16	20	25	32	40	50	63
A+ (slaglengte 0 - 50)	42	53	53,5	97	91	106,5	406,5
A+ (slaglengte 75 - 200)	64,5	84,5	85	102	102	118	118
B+	46	53	53,5	59,5	66	72	77
C+	33	37	37,5	37,5	44	44	49
Ø DA	8	10	10	12	12	16	16
Ø DB	10	12	16	20	20	25	25
E (slaglengte 0-50)	0	0	0	37,5	31	29,5	34,5

E (slaglengte 75 - 200)	18,5	31,5	31,5	42,5	36	46	41
FA	8	10	10	10	10	15	15
FB	5	6	6	12	12	13	13
G	30,5	36,8	42,8	49	55	65	79
GA	11	11,5	11,5	12	15	15	15,5
GB	8	9	10	9	12	12	13,5
H	64	84	94	113	121	149	163
HA	M4	M5	M5	M6	M6	M8	M10
HB	32,5	41,5	46,5	56	60	74	81
HC	32	42,5	47,5	57	61	75	82
J	15	18	21	24	27	32	39
K	15,5	18,8	21,8	25	28	33	40
L	22	24	30	34	40	46	58
MM	M5	M5	M6	M8	M8	M10	M10
ML	12	13	15	16	16	20	22
NN	M5	M5	M6	M8	M8	M10	M10
OA	4,2	5,2	5,2	6,5	6,5	8,5	8,5
OB	8	9,5	9,5	11	11	14	14
OL	4,5	5,5	5,5	7,5	7,5	9	9
P	M5	G1/8"	G1/8"	G1/8"	G1/8"	G1/4"	G1/4"
PA+	15	13,5	12,5	6,5	13	9	13
PB	10	11	14	16	18	21,5	28
PW	19	25	30	35,5	39,5	47	58
Q	16	18	26	30	30	40	50
R	54	70	78	96	104	130	130
S	25	30	40	45	45	60	70

T	62	81	91	110	118	146	158
U	46	54	64	78	86	110	124
VA	56	72	82	98	106	130	142
VB	38	44	50	63	72	92	110
VC	10,5	12,5	15	19,5	25	33	34
WA (slaglengte 0-30)	24	24	24	24	24	24	28
WA (slaglengte 40-100)	44	44	44	48	48	48	52
WA (slaglengte 125-200)	110	120	120	124	124	124	128
WB (slaglengte 0-30)	17	29	29	33	34	36	38
WB (slaglengte 40-100)	27	39	39	45	46	48	50
WB (slaglengte 125-200)	60	77	77	83	84	86	88
X +/- 0,02	24	28	34	42	50	66	80
Ø XA H9	3	3	4	4	4	5	5
XB	3,5	3,5	4,5	4,5	4,5	6	6
XC	3	3	3	3	3	4	4
XL	6	6	6	6	6	8	8
YY	M5	M6	M6	M8	M8	M10	M10
YL	10	12	12	16	16	20	22
Z	6	17	17	21	22	24	24
a	4,4	5,4	5,4	6,5	6,5	8,5	11
b	7,4	8,4	8,4	10,5	10,5	13,5	17,8

c	3,7	4,5	4,5	5,5	5,5	7,5	10
d	3,5	3,6	3,8	4,5	5	5,5	8
e	6,7	8,6	9	10,5	10,5	14,5	19,5

## Additional Information

---

EAN Code	8719426556252
Artikelnummer	EDMW32-150
Arbeidstemperatuur max. in °C	80
Arbeidstemperatuur min. in °C	-20
Afdichting zuigerstang	NBR
Draadmaat op poorten	1/8"
Draadsoort op poorten	BSP
Einddemping instelbaar	Ja
Einddemping	Ja
Kracht in (N)	415
Kracht uit (N)	483
Legering kappen	Geanodiseerd aluminium
Magnetisch	Ja
Materiaal zuigerstang	CHROOMSTAAL C45
Materiaal buis	Geanodiseerd aluminium
Max. druk (bar)	10
Merk	Artec
Min. druk (bar)	1
Diameter	Ø 32 mm
Slaglengte	150 mm